



SKINROCK WEST

2026

todd@skinrockwest.com
Todd: 8012432496
[Office: 8019300772](tel:8019300772)

121 w election Rd, suite 320
Draper, UT 84020

jeff@skinrockwest.com
Jeff : 3852585840

www.skinrockwest.com



Skinrock® USA is dedicated to the research, production, and global distribution of ultra-thin natural stone veneer and advanced stone composite solutions. Using state-of-the-art slicing and bonding technology, Skinrock transforms premium natural stone — including granite, marble, limestone, and slate — into ultra-thin flexible stone sheets ranging from approximately **1mm to 3mm (0.04" – 0.12")** in thickness, while preserving the authentic texture, color, and character of real stone. Skinrock panels can be reinforced with fiberglass, resin backing, PVC, cement boards, aluminum composite panels, honeycomb panels, glass, and other substrates to meet diverse architectural requirements. Standard and custom panel sizes are available, with large-format sheets up to approximately **4' x 8' (1220 x 2440 mm)** and custom formats reaching **5' x 10' (1520 x 3050 mm)** upon request. This provides architects and designers with complete flexibility for both interior and exterior applications. The product range covers a full spectrum of specifications, finishes, and formats, suitable for façades, feature walls, bathrooms, commercial interiors, hospitality spaces, and retail environments.

Skinrock adopts a multilayer composite structure that significantly enhances tensile strength, impact resistance, and long-term durability. Compared with traditional stone slabs, Skinrock offers outstanding advantages in **weight reduction, installation efficiency, and transportation cost savings**, while maintaining the visual authenticity of solid stone. These benefits make Skinrock widely favored by designers, contractors, and developers seeking lightweight, high-performance stone solutions. In recent years, Skinrock products have been selected for numerous high-end residential, commercial, hospitality, and public projects across North America and international markets. These projects demonstrate Skinrock's consistent quality, advanced manufacturing standards, and architectural reliability. Skinrock is committed to the principle of **"Quality First, Customer Oriented."** We continuously invest in product innovation, technical improvement, and service excellence, working closely with our partners to create sustainable, elegant, and forward-looking architectural solutions.

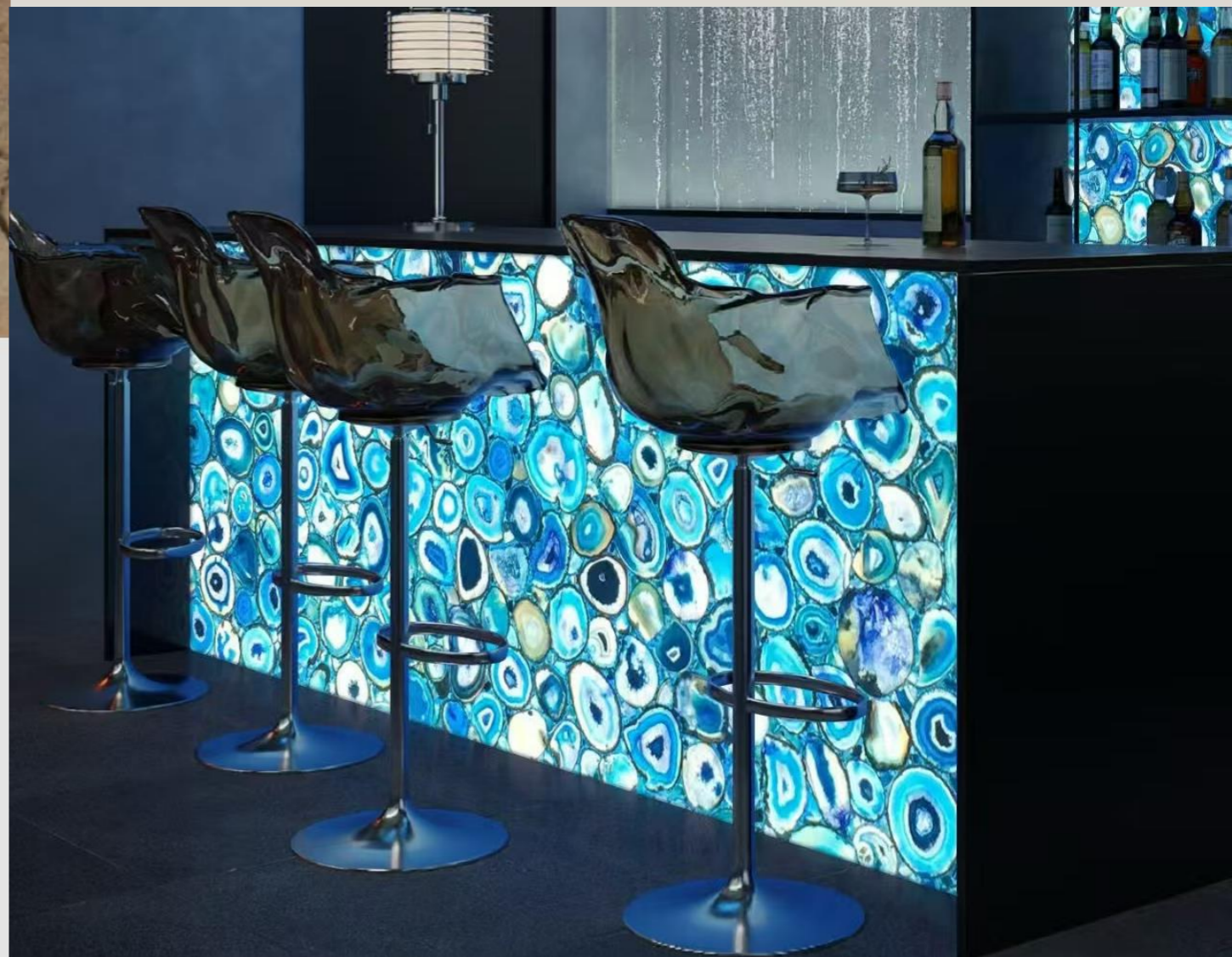

SKINROCK® ARCHITECTURAL STONE SURFACES

"Where Elegance Meets Comfort"

SKINROCK USA

ULTRA LIGHT ULTRA THIN

Discover ultra-thin natural stone surfaces designed to transform architectural spaces with elegance, authenticity, and modern performance.

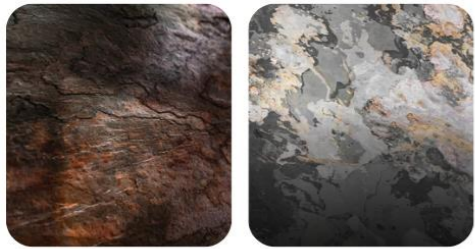

REAL NATURAL STONE

Ultra-thin veneers crafted for modern architectural design.



DESIGN WITHOUT LIMITS

Lightweight, flexible, and easy to install on any surface.

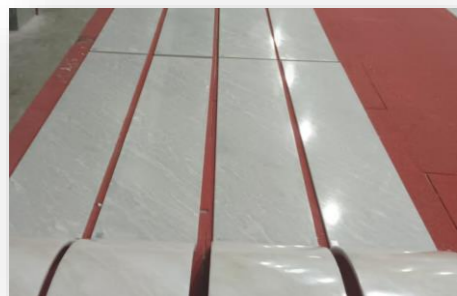

Logistically Intelligent & Environmentally Responsible

Skinrock® ultra-thin stone weighs only a fraction of traditional slabs, reducing transportation costs and making handling much easier on site. More coverage per shipment means lower freight expenses and a smaller carbon footprint — a smarter, more sustainable way to use real natural stone.

PRODUCT ADVANTAGES



Material Weight

Skinrock® natural stone veneer weighs only a fraction of traditional stone, making it easy to transport, handle, and install. With an average weight of approximately **10 oz per sq.ft (≈ 3 kg per m²)**, Skinrock delivers authentic stone beauty without the structural load, allowing application on walls, furniture, ceilings, and curved surfaces where natural stone was previously impossible, and artistic architectural applications..



Natural Translucency

Selected Skinrock® stone surfaces feature natural translucency, allowing light to pass through the stone and reveal its organic depth and texture. When backlit, the material creates a dramatic visual effect that highlights the unique veining and structure of each slab, making it ideal for feature walls, bars, reception areas, lighting panels, and artistic architectural applications..



Natural Surfacing

Every Skinrock® sheet preserves the authentic surface of real natural stone. No two pieces are identical — each panel features unique textures, veins, and color variations created by nature itself. This guarantees a genuine stone appearance while delivering the flexibility and performance of a modern architectural material.



Flexible Design Possibilities

Unlike traditional stone, Skinrock® sheets are lightweight and flexible. They can be applied to curved walls, columns, furniture, ceilings, and other complex surfaces. This allows architects and designers to use real stone in places that were previously difficult or impossible.



Easy to Fabricate

Skinrock® can be cut, drilled, and shaped using common woodworking or stone tools. Panels can be customized quickly for precise project needs. This makes integration into cabinetry, feature walls, and custom details simple and efficient.



Easy to Install

Skinrock® installs with standard construction adhesives on drywall, MDF, concrete, plywood, and other common substrates. Its lightweight structure reduces labor effort, speeds up installation, and eliminates the need for heavy structural support.



SKINROCK USA



CARRARA MARBLE
A timeless white marble defined by soft grey veining and natural depth. Carrara brings brightness and quiet sophistication to interiors, making it ideal for showers, feature walls, and contemporary architectural applications.

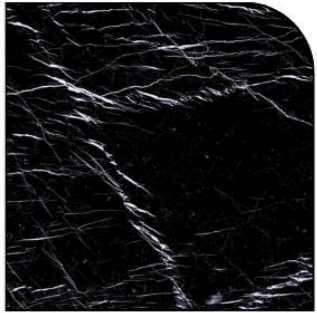

NERO MARQUINA
A deep black marble highlighted by bold white veining. Nero Marquina creates dramatic contrast and strong visual identity, perfect for statement walls, luxury bathrooms, and modern hospitality spaces.

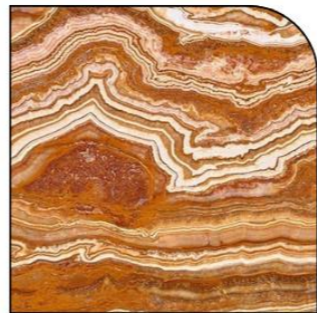

TIGER ONYX
A striking translucent stone with layered amber, gold, and cream banding. Tiger Onyx delivers warmth and movement, especially when backlit, creating a refined focal point in premium interiors.



JUNGLE FIRE
A vibrant natural stone featuring rich earth tones, dynamic veining, and organic patterns. Jungle Fire adds energy and character to architectural spaces seeking bold material expression.

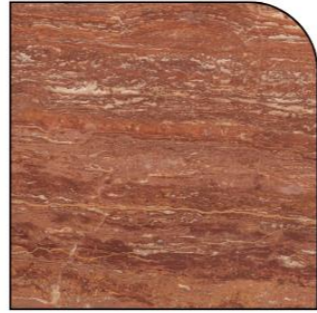

RED TRAVERTINE
A warm, textured stone with deep red and rust undertones. Its natural pores and tonal variation bring authenticity and Mediterranean character to interior and exterior applications.

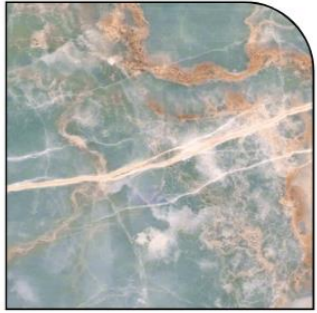

BLUE ONYX
A rare translucent stone with cool blue, ivory, and crystalline veining. Blue Onyx offers luminous depth and dramatic elegance, particularly suited for backlit installations and high-end design features.

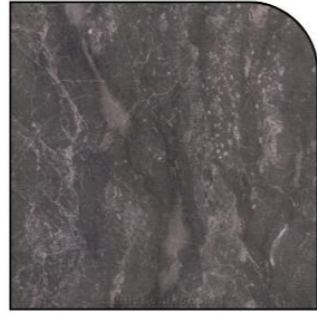

GRAY GALAXY
A deep gray stone with subtle crystalline highlights, delivering modern sophistication and understated elegance.

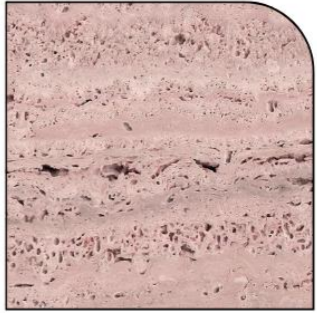

ROMAN TRAVERTINE
A warm beige stone with natural linear texture, offering timeless Mediterranean character for refined architectural surfaces.

Feature	Skinrock USA	Slate-Lite	StoneVeneerPro	Richter FlexStone
Thickness	~1–5 mm	~1.5–8 mm	~2–5mm	~1.5–8 mm
Flexibility	Very High	High	Moderate	High
Rock Selection	90+ Real Stone Types	~20 Types	~12 Types	~15 Types
Backing Materials	Resin, Fiberglass, PVC, Aluminum, Honeycomb	Fiberglass Mesh	PVC & Fiberglass Mix	Fiberglass & Polymer
Customization Options	CNC Routing, Laser Engraving, 3D Carving, Backlighting Integration	Limited	Some CNC Compatible	Limited
U.S. Stock & Support	Full U.S. Distribution	Often Requires Import	U.S.-Based Shipping	Limited U.S. Availability
Weight per ft²	0.4 – 1 lb/ft²	0.31 – 0.51 lb/ft² (stiff)	0.61 – 0.82 lb/ft²	0.45 – 0.72 lb/ft²
Surface Texture	Natural for Slate & Quartzite; Raw, Polished or Honed for Marbles	Polished or Flattened	Varies by Product	Often Uniform
Sustainability	LEED Eligible, Low Environmental Impact	Some Eco Claims	Not Specified	Claims Sustainable Materials



The following stones illustrate a selection of available natural surfaces. Each design is fabricated as an ultra-thin, fiberglass-reinforced panel, preserving the authenticity of solid stone in a lightweight architectural format.



Creating a modern and luxurious space is not only about expressing a bold architectural vision, but also about the intelligent selection of materials, advanced production technology, and thoughtful design strategy. Through innovative manufacturing processes, refined craftsmanship, and the creative experience of designers, Skinrock® transforms natural stone into a new architectural language — lighter, more flexible, and more expressive.



Through advanced manufacturing processes, lightweight engineering, and precision craftsmanship, Skinrock® delivers a high-performance exterior cladding that withstands the elements while maintaining the elegance of natural stone. At the same time, it empowers designers with flexibility, ease of installation, and creative freedom. The result is a seamless architectural language—durable, sophisticated, and expressive from the inside out.



STONE COMPOSITED TYPES

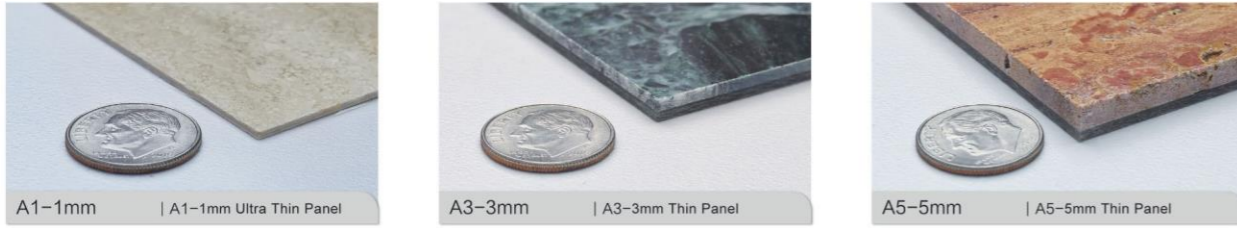

Ultra-Lightweight. Structurally Intelligent.

Engineered to be up to **90% lighter than traditional solid stone**, Thin Panels dramatically reduce structural load while simplifying transport and handling.

Ideal for high-rise façades, ceilings, feature walls, and retrofit applications where weight matters.



STONE COMPOSITED TYPES

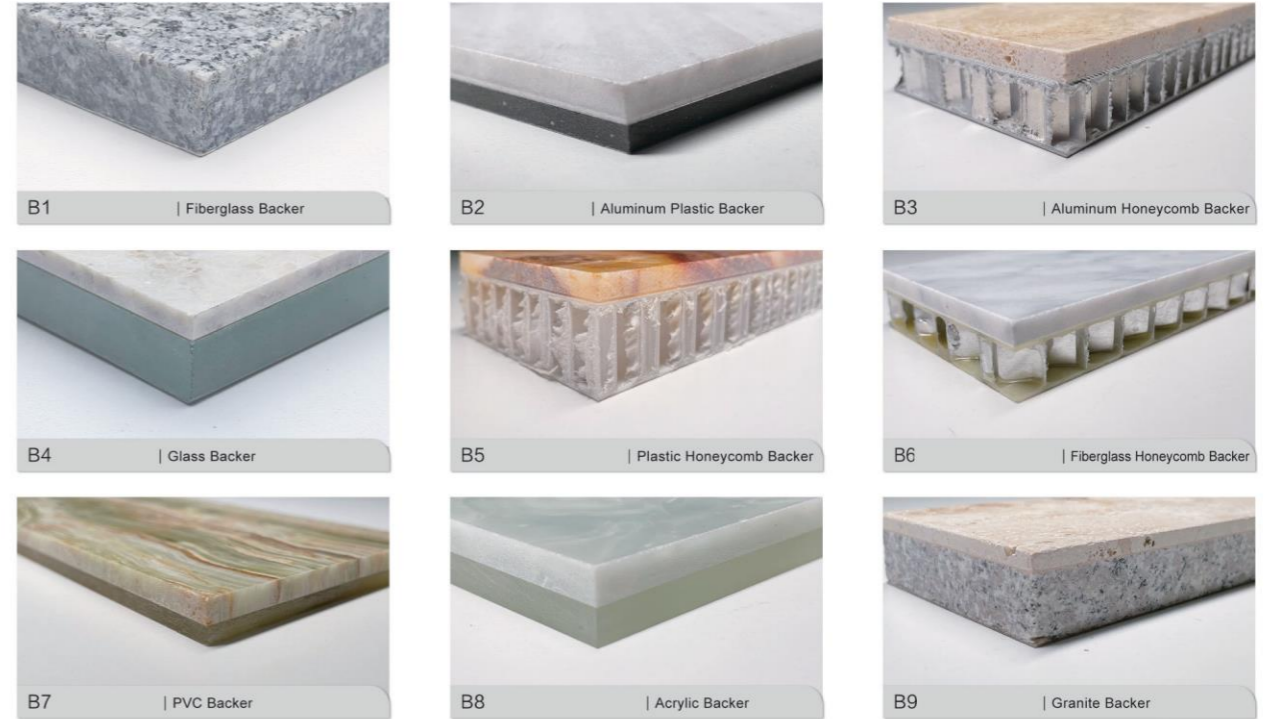

Engineered Strength & Reliability

Advanced lamination technology bonds natural stone to high-performance backers such as aluminum honeycomb and ceramic substrates.

The result: enhanced flexural strength, improved impact resistance, and significantly reduced breakage — without compromising the authentic beauty of real stone.

Responsible Material Innovation

By using ultra-thin natural stone surfaces combined with engineered backing systems, raw stone consumption is significantly reduced.

This smarter material composition improves resource efficiency while maintaining the visual integrity of full-depth stone.

Thin Skinrock vs Traditional Materials

Category	Thickness	Weight	Maximum Size	Structural Performance	Transportation Efficiency	Installation Method
Veneer Skinrock Slabs	1/32" – 3/16"	0.4 – 1.0 lbs/ft ²	Up to 80.7" × 128" (depends by slab size)	High flexural strength, flexible, impact-resistant backing system	Ultra-lightweight, low breakage risk, reduced freight costs	Adhesive installation system
Traditional Stone (Solid Slab)	3/4" – 1 1/4" (20–30mm typical)	10 – 18 lbs/ft ²	Up to 80.7" × 128" (depends by slab size)	Very high compressive strength, rigid, brittle under flexural stress	Heavy, high breakage risk, higher shipping and handling costs	Wet installation with mortar or mechanical anchoring
Man made Slab (Porcelain)	1/4" – 1/2" (6–12mm typical)	3 – 6 lbs/ft ²	Up to 63" × 126" (varies by manufacturer)	High surface hardness, rigid, prone to cracking under impact	Moderate weight, careful handling required	Adhesive installation system

Shower Systems



Skinrock® shower surfaces are unique architectural stone solutions designed specifically for modern bathroom environments. Using ultra-thin natural stone panels tailored to shower dimensions, Skinrock® allows seamless wall applications with reduced weight and simplified installation.

Skinrock® systems can be combined with customized trims, soap niches, wall accents, and integrated accessories, offering complete design freedom. A wide selection of marble, limestone, slate, and quartzite stones is available to suit different aesthetic and functional requirements.

Height	Configuration	Dimensions
96"	Double Panel	38" x 96"
96"	Single Panel	63" x 96"
120"	Double Panel	38" x 120"
120"	Single Panel	63" x 120"

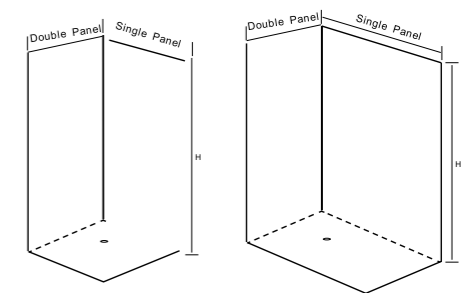

Technical Advantages

- Ultra-thin natural stone (≈1–5 mm)
- Weight: only **0.6 lb/ft² (≈3 kg/m²)** Depends on the material
- Large-format panels up to **48" × 98" (1220 × 2500 mm)**
- Fewer joints than tiles = cleaner appearance
- Ideal for walk-in showers & wet rooms



Natural stone panels engineered for modern wet areas.

Skinrock shower surfaces are designed specifically for contemporary bathroom environments. Using ultra-thin natural stone panels, Skinrock allows for seamless wall applications with reduced weight and simplified installation.

With large-format panels and minimal joints, Skinrock creates a clean, continuous stone appearance while maintaining the authentic texture and character of real stone.

Skinrock® shower systems are designed for seamless renovation. Thanks to their ultra-thin and lightweight structure, installation requires **no demolition**, reducing labor time, dust, and structural disruption.

The panels can be applied directly over existing surfaces, delivering a refined natural stone finish with minimal downtime and maximum efficiency.





TYPICAL APPLICATIONS

Skinrock shower panels are designed for a wide range of interior wet-area environments, combining natural stone aesthetics with lightweight performance.

Residential

- Walk-in showers
- Wet rooms
- Master bathrooms
- Feature shower walls

Hospitality & Wellness

- Hotel bathrooms
- Spa and wellness areas
- Boutique resorts
- Luxury apartments

Design-Oriented Spaces

- Statement shower walls
- Integrated wall niches
- Vanity backsplash
- Architectural bathroom concepts





Skinrock® supplies ultra-thin natural stone panels as well as solid stone vanity tops in consistent color tones, creating bathrooms that feel refined, harmonious, and truly luxurious. The combination of lightweight architectural surfaces and solid stone elements allows designers to achieve a unified stone aesthetic with enhanced performance and design flexibility.

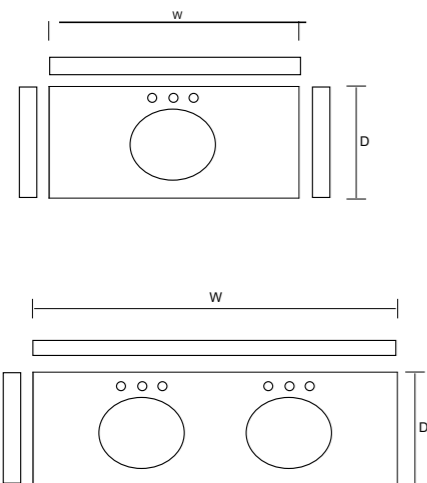
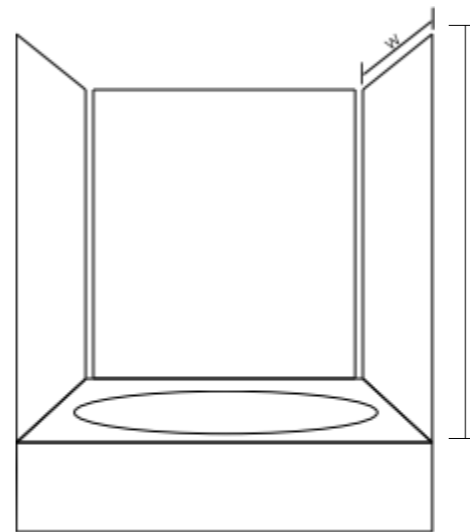

Model Width	Depth	Sink Type
24"	21"	Single
36"	21"	Single
42"	21"	Single
48"	21"	Single / Compact Double
60"	21"	Double

Standard U.S. vanity widths with 21" depth for seamless integration into residential and commercial projects. Custom dimensions and fully integrated stone configurations available upon request.

Height	Configuration	Dimensions
96"	Double Panel	38" × 96"
96"	Single Panel	63" × 96"
120"	Double Panel	38" × 120"
120"	Single Panel	63" × 120"

Optimized panel configurations based on standard U.S. shower heights. Designed for efficient installation, reduced weight, and continuous stone aesthetics.





KITCHEN



Natural Stone for Modern Kitchens

Skinrock® brings the beauty of real natural stone into contemporary kitchen design. Ultra-thin, lightweight, and refined, Skinrock® surfaces create elegant backsplashes, islands, cabinet panels, and feature walls that combine luxury aesthetics with everyday practicality.

INSTALLATION GUIDE



SCAN ME

ROUGH SPLIT LINE

Rough Split Marble



98" x 48" (2500 x 1200 mm)

BECAUSE OF THE NATURAL CHARACTERISTICS COLORS AND PATTERNS WILL VARY



Sea White



Arctic Storm



Fantasy White

(M)



Cosmos



Mountain Line



Desert Storm



Rainbow



Graphito



Sparkle



Swiss Valley Grey



Fantasy Red



Black Galaxy



Sparkle



Atlantic White



Manson Black



Ocean White

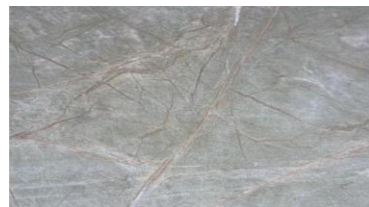

Forest Green



Forest Brown



Oak White



Turkish White



Panda White



Sea White

Rough Split Slate



98" x 48" (2500 x 1200 mm)
9D

BECAUSE OF THE NATURAL CHARACTERISTICS COLORS AND PATTERNS WILL VARY



Mother Earth



Fresh Earth



Golden Drops



Steel Black



Lime White



Purple Gray



South Grey



Multi Pink



Wood Rot



Ocean Black

Rough Split Quartzite

1-5mm

SIZE

98" x 48" (2500 x 1200 mm)
Custom size per request

BECAUSE OF THE NATURAL CHARACTERISTICS COLORS AND PATTERNS WILL VARY



Ocean Green



Jungle Fire

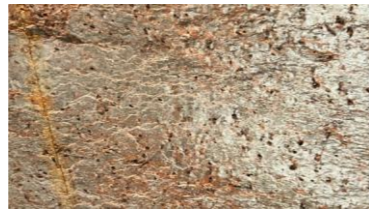

Copper Natural



Shining Hill



Shining Leaves



Shining Tree

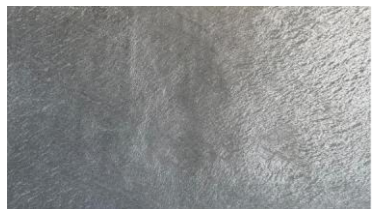

Silver Galaxy



Steel Gray

Sandstone

1-5mm

SIZE

98" x 48" (2500 x 1200 mm)
Custom size per request

BECAUSE OF THE NATURAL CHARACTERISTICS COLORS AND PATTERNS WILL VARY

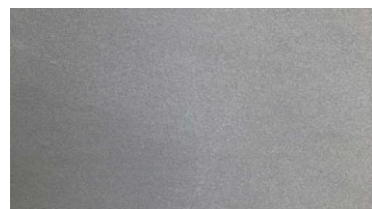

Swiss Gray



Rainbow

Iconic Line

The Luxury Selection represents Skinrock's most refined marble surfaces, selected for their elegance, color depth, and architectural prestige. These ultra-thin natural stone veneers combine timeless beauty with modern performance, offering designers and architects unlimited creative freedom without structural limitations. Each surface preserves the authentic character of natural marble while delivering exceptional lightness, flexibility, and ease of installation.



Luxury Selection

1-3mm

Depends on the backing Material

SIZE

98" x 48" (2500 x 1200 mm)
Custom size per request

BECAUSE OF THE NATURAL CHARACTERISTICS COLORS AND PATTERNS WILL VARY

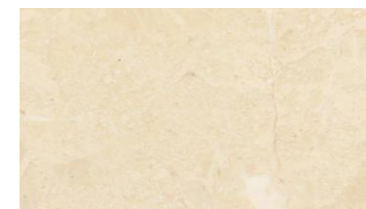

Cream Marfil

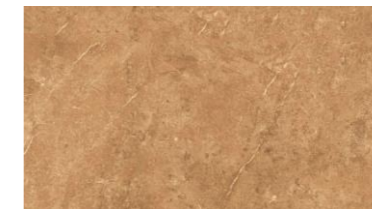

Light Emperador



Nero Marquina

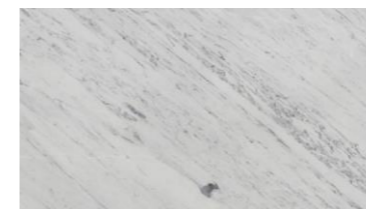

White Carrara



Calacatta Viola



Calacatta Vagli

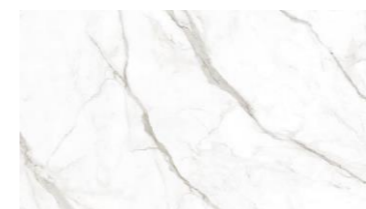

Calacatta Oro

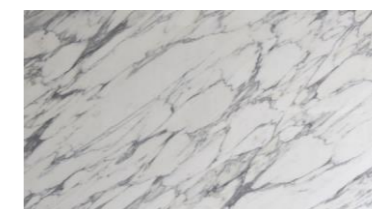

Calacatta Statuario

Luxury thickness varies depending on the selected stone. Each panel is precision-crafted using full CNC and laser technology to ensure exceptional accuracy and consistency. Distributed across North America, the Lux collection weighs approximately 0.4 to 1.0 lb per square foot, delivering premium aesthetics with remarkably low weight.

EXPANDED RANGE LINE

New textures. Broader material families. Greater design freedom.



Selected Quartzite

1-8 mm

SIZE

96" x 48" (2500 x 1200 mm)
Custom size per request

BECAUSE OF THE NATURAL CHARACTERISTICS COLORS AND PATTERNS WILL VARY



Universe Black



Silk Way



Sky Blue



Rainbow



Taj Mahal



Azul Patagonia



Crema Patagonia



Tiffany



Elegant Brown



Azul Macaubas

MARBLE



1-5mm



98" x 48" (2500 x 1200 mm)
Custom size per request

BECAUSE OF THE NATURAL CHARACTERISTICS COLORS AND PATTERNS WILL VARY

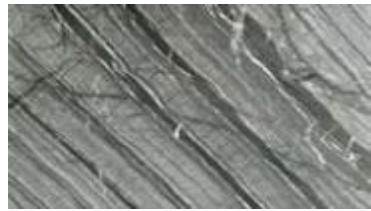

Antique Wood

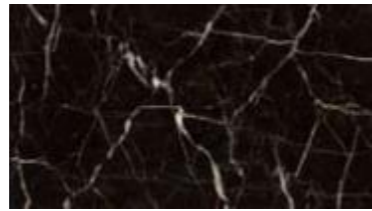

ST. Laurent Brown

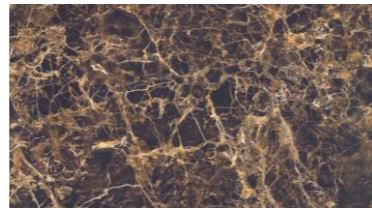

Dark Emperador



Rosso Levanto



Tempera



Teak Wood White



French Mocha

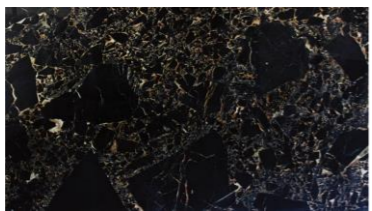

Atens Portoro



Sofitel Gold



Rainforest Brown



Rainforest green



Gray Galaxy



Ziluo White



Michelangelo



Bianco Carra

TRAVERTINE



1-5mm



98" x 48" (2500 x 1200 mm)
Custom size per request

BECAUSE OF THE NATURAL CHARACTERISTICS COLORS AND PATTERNS WILL VARY



Ivory Beige Travertine



Roman Travertine



Gray Travertine

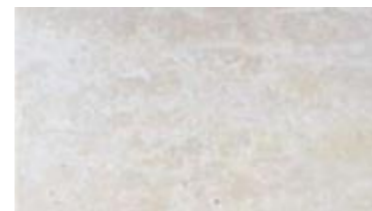

Ivory Travertine



Walnut Travertine



Nice Travertine



Gold Natural line Travertine



Pink Travertine



Silver Travertine



Gold Travertine



Red Travertine



Italy Silver Travertine

ONYX

1-5 mm

SIZE

98" x 48" (2500 x 1200 mm)
Custom size per request

BECAUSE OF THE NATURAL CHARACTERISTICS
COLORS AND PATTERNS WILL VARY



Shangri-La



Bamboo Onyx

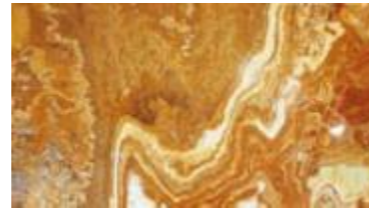

Tiger Onyx

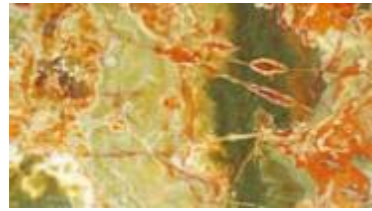

Green Onyx

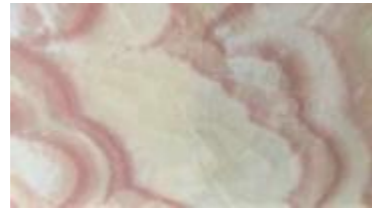

Red Dragon



Honey Onyx



Yellow Onyx



White Wain



White Flower



White Onyx



Blue Onyx



Grey Onyx

GRANITE

1-5 mm

SIZE

98" x 48" (2500 x 1200 mm)
Custom size per request

BECAUSE OF THE NATURAL CHARACTERISTICS
COLORS AND PATTERNS WILL VARY



Majestic Mauve

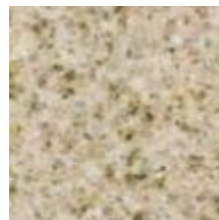

Golden Peach



Bala Flower



Baltic Brown



Avocado Green



Tan Brown

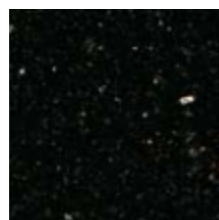

Black Galaxy

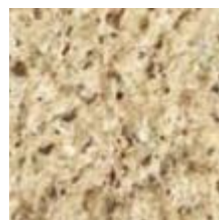

Giallo Ornamentale Dark

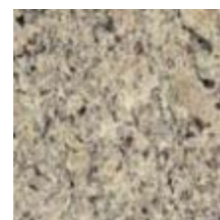

Giallo Ornamentale

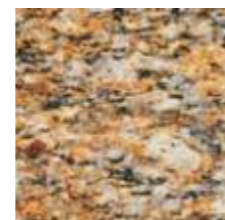

Santa Cecilia

SELECTED RESERVE

1-5 mm

SIZE

98" x 48" (2500 x 1200 mm)
Custom size per request

BECAUSE OF THE NATURAL CHARACTERISTICS
COLORS AND PATTERNS WILL VARY



Bianco Antico



Elegant Brown

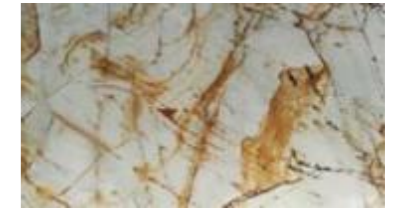

Picaso



Blue Sky



Azul Bahia



Green Quartz

AGATE

20mm

SIZE

98" x 48" (2500 x 1200 mm)
Custom size per request

BECAUSE OF THE NATURAL CHARACTERISTICS
COLORS AND PATTERNS WILL VARY



WHITE AGATE



YELLOW AGATE



BLUE AGATE



COLORFUL AGATE



AMETHYST

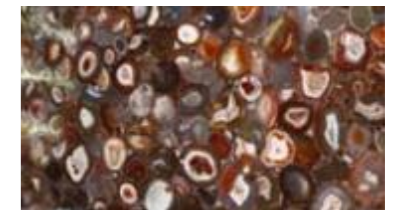

RED AGATE

PANELS APPLICATION

Skinrock® Thin Panels are increasingly recognized as a leading choice in modern construction. Our ultra-thin stone solutions have been used in numerous residential and commercial projects across local and international markets.



Unlimited Design Possibilities

At Skinrock, every surface begins with real, natural stone — and that means virtually **any color, texture, or pattern found in nature can be transformed into a lightweight stone panel system.**

From classic Italian marbles and dramatic Brazilian quartzites to minimalist limestones and bold exotic granites, our technology allows us to produce panels from **almost any slab selection worldwide.**

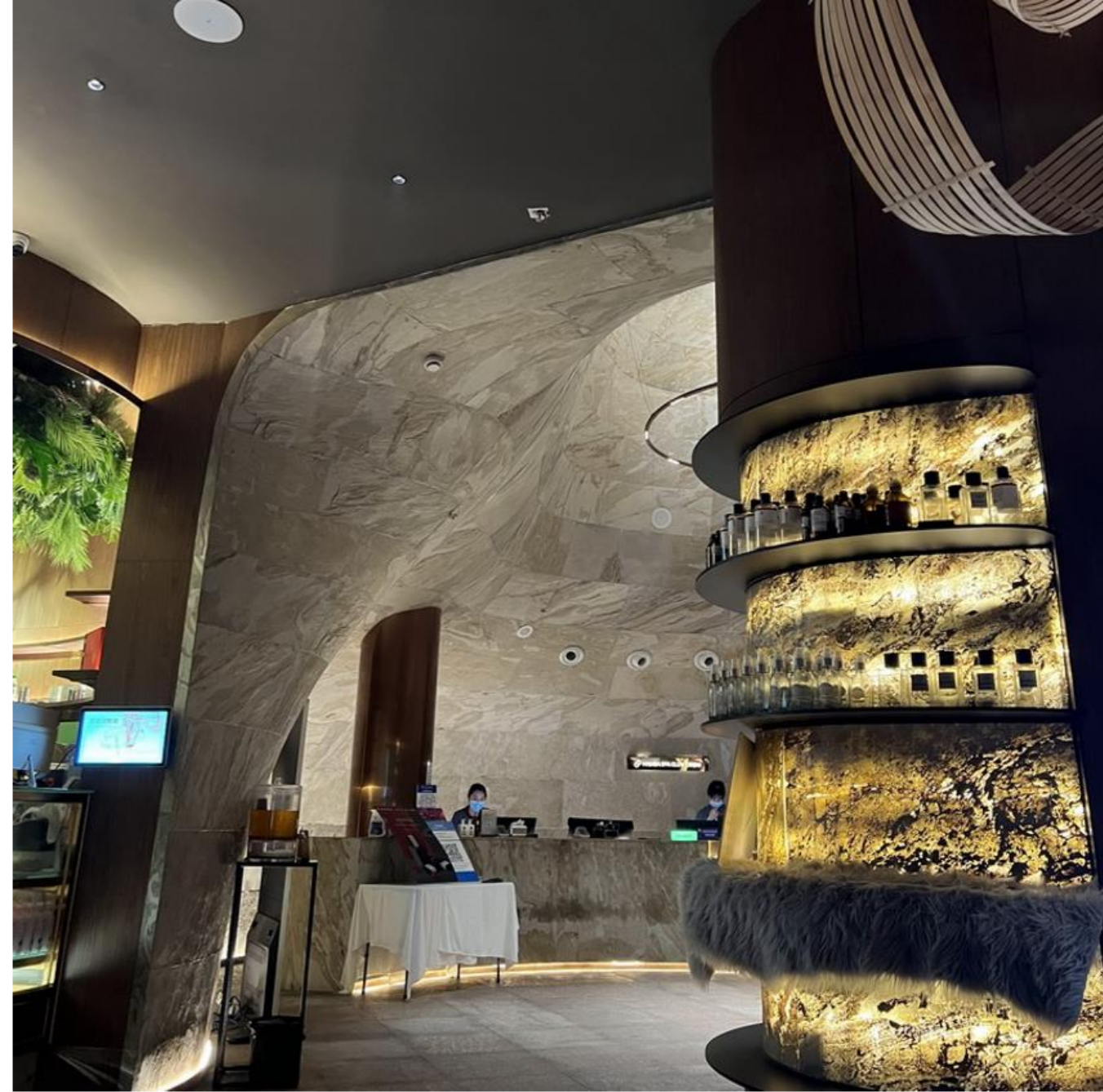

While certain finishes remain highly sought after — such as Calacatta whites, warm travertines, and contemporary greys — our capabilities are not limited to a fixed collection. If it exists as a slab, it can become Skinrock.

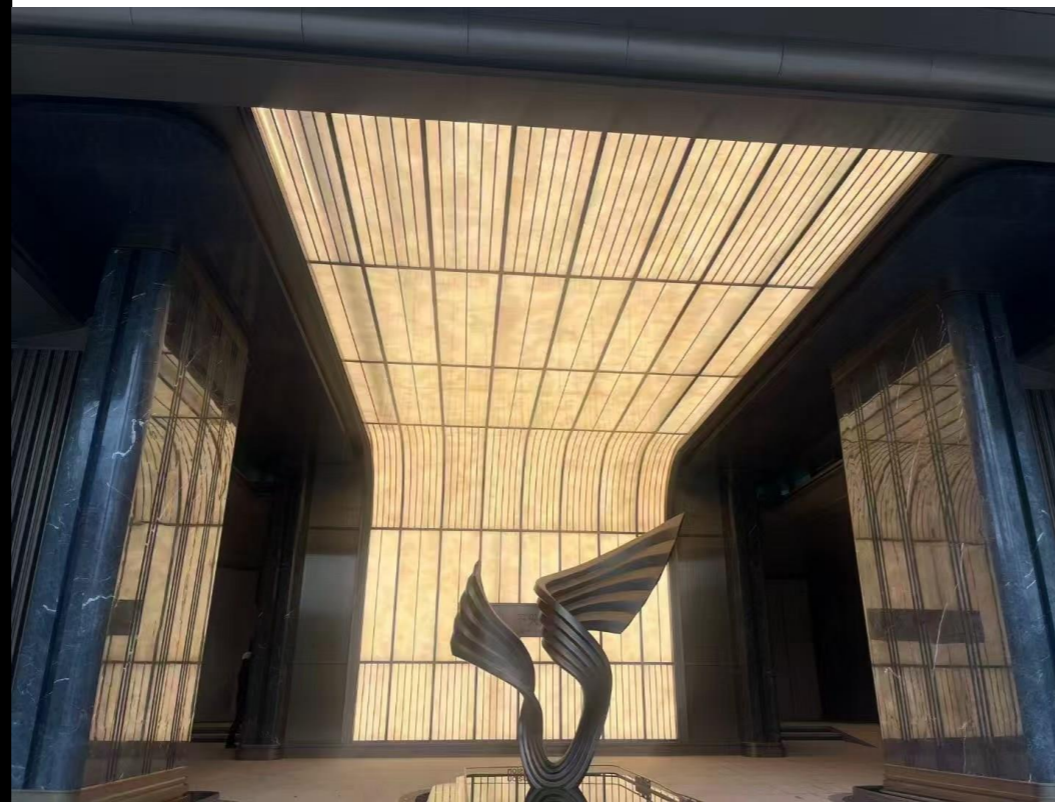

This capability provides architects, designers, and developers with exceptional creative freedom:

- Seamlessly match project-specific stone specifications
- Replicate regional materials for global installations
- Maintain visual continuity across large-scale developments
- Create bespoke, signature surfaces with reduced structural load

By preserving the authentic beauty of natural stone while redefining its performance characteristics, Skinrock enables design without compromise.

Your vision defines the material — not the other way around.